

1

2

3

4

A

B

C

D

E

A

B

C

D

E

kotłierz/flange/Фланец

DN125 PN16

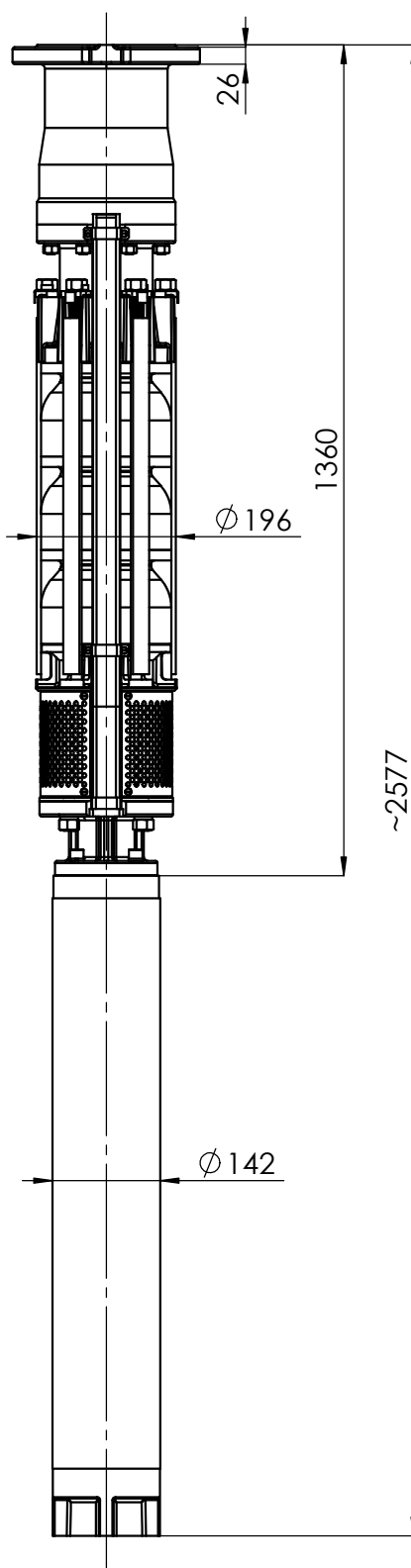
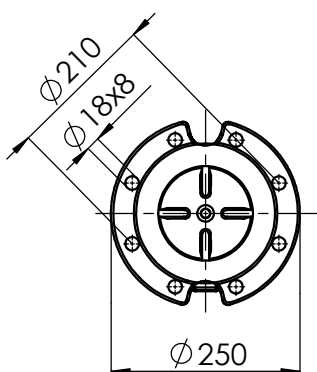

masa/weight/вес:~200kg

6"

HYDRO-VACUUM S.A.

GCA.6.05.2110_6_30kW

30kW

GRUDZIĄDZ

400/500V

ul. Droga Jeziorna 8