

1

2

3

4

A

B

C

D

E

A

B

C

D

E

kotnierz/flange/Фланец

DN125 PN16

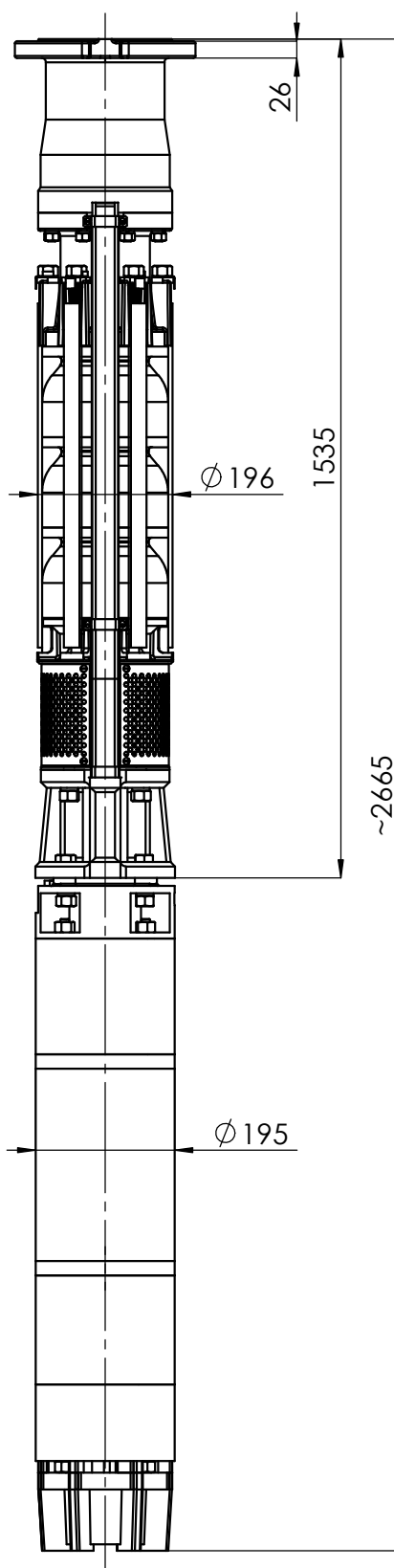
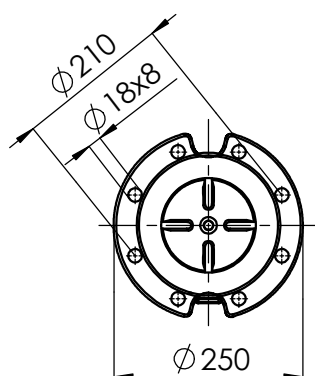
masa/weight/вес: ~ 273 kg

GCA.7.06.1110_8_45kW

8"

45kW

400/500V

HYDRO-VACUUM S.A.

GRUDZIĄDZ

ul. Droga Jeziorna 8