

Agregat pompowy OPA.2.02

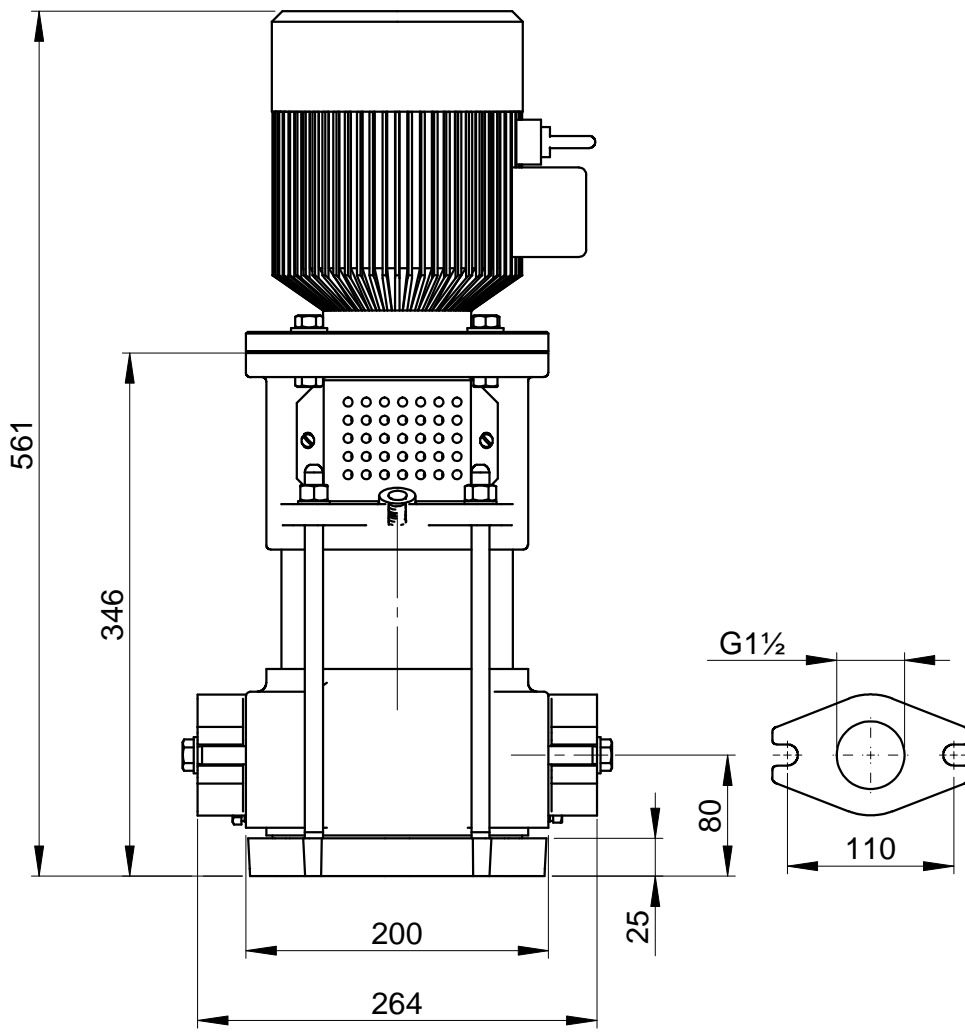

W ↑

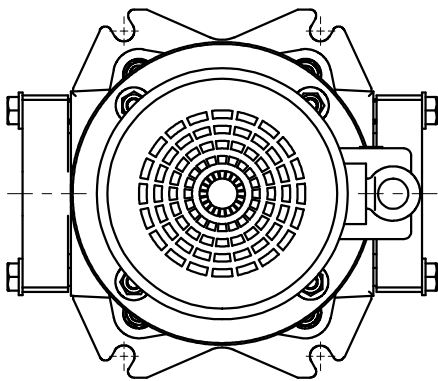

Widok „W”

