

Agregat pompowy OPA.2.03

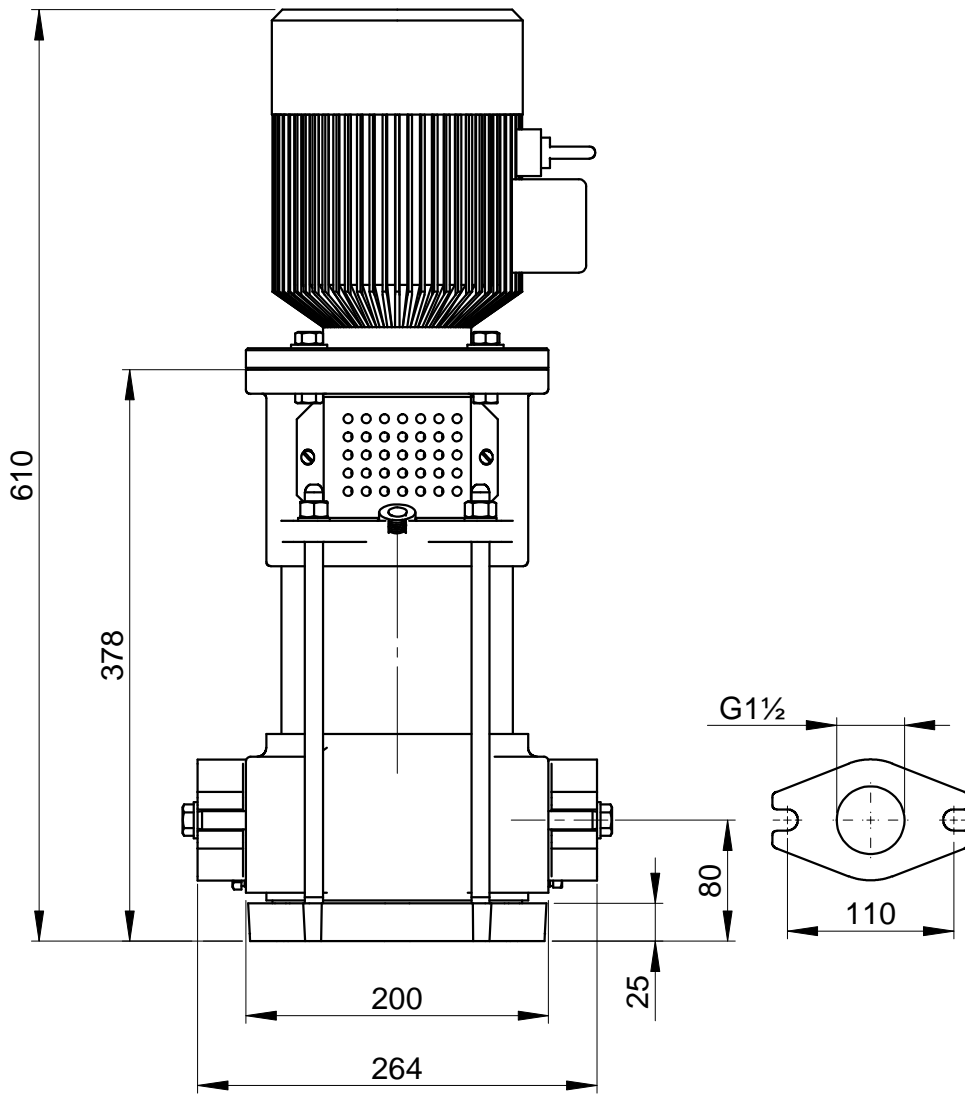

W ↑

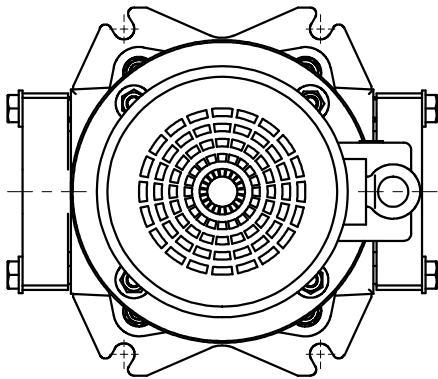

Widok „W”

