

Agregat pompowy OPA.2.08

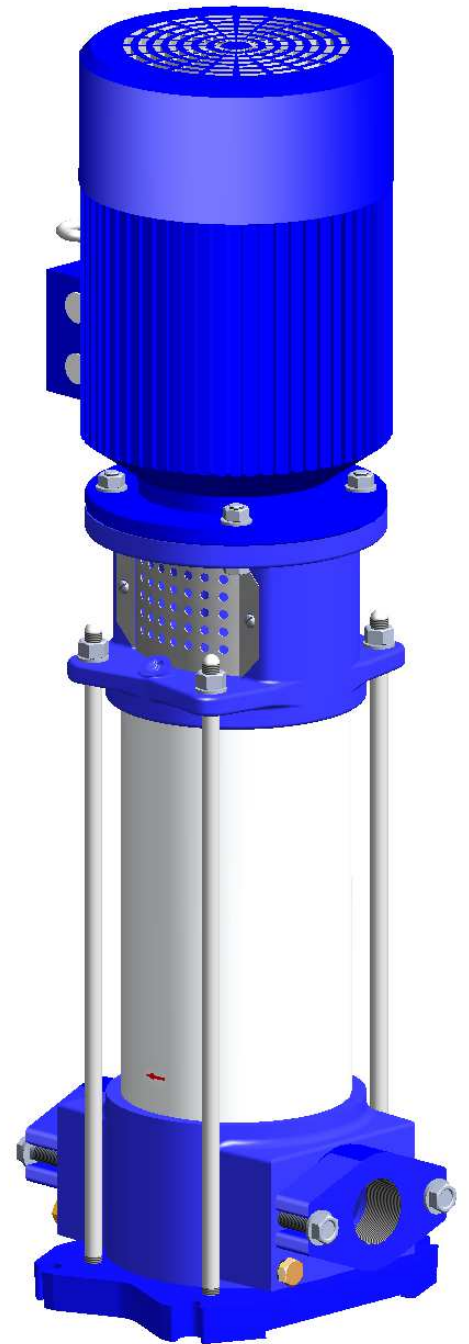

Widok „W”

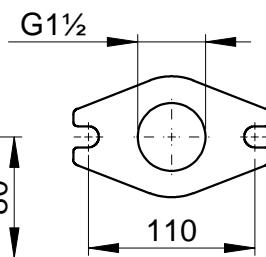
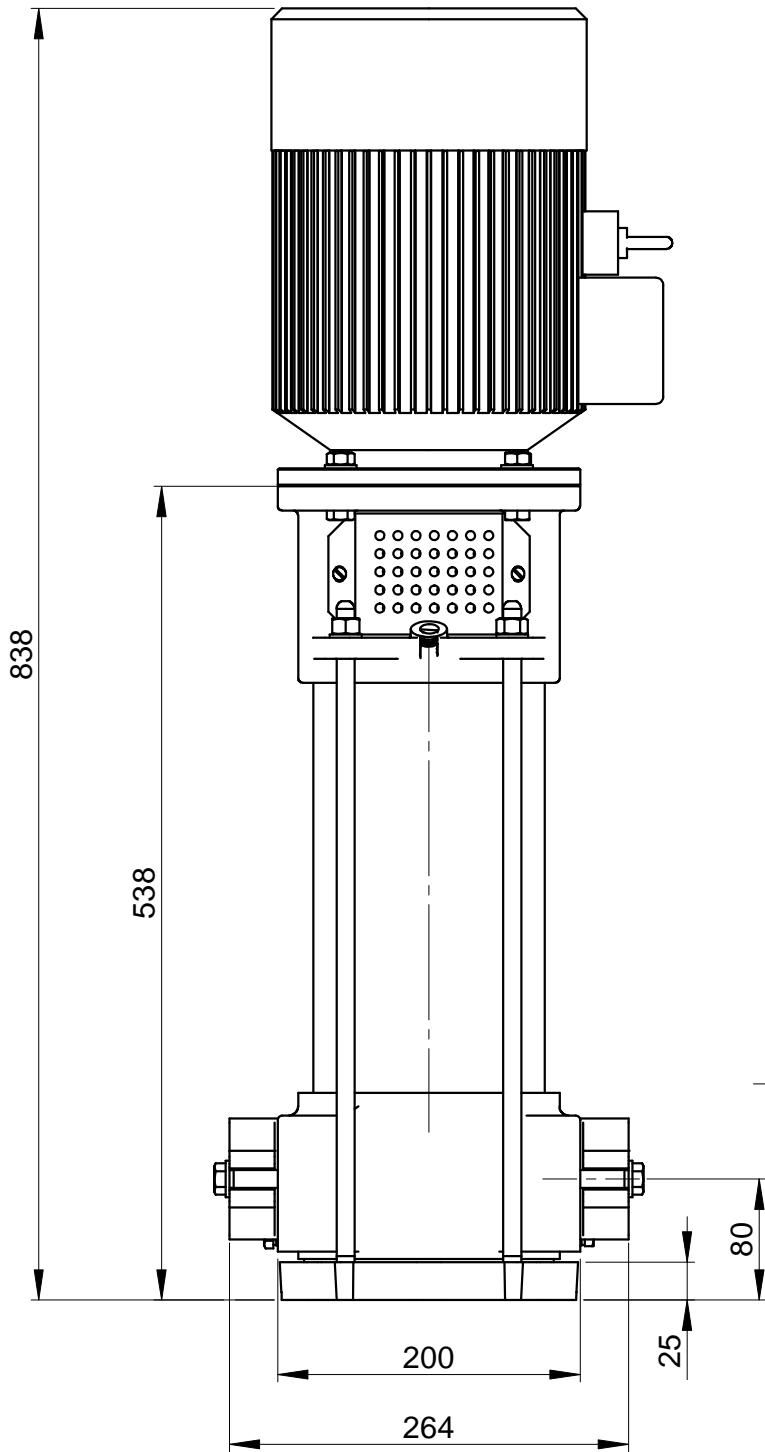